



## Single-Band Monopole Antenna Design and Production

---

Wen-Cheng Lai and Lin-Chuan Tsai

EasyChair preprints are intended for rapid dissemination of research results and are integrated with the rest of EasyChair.

April 6, 2019

# SINGLE-BAND MONOPOLE ANTENNA DESIGN AND PRODUCTION

<sup>1</sup>Wen-Cheng Lai, <sup>2</sup>Lin-Chuan Tsai

<sup>1</sup> Dept. of Electronic Engineering Ming Chi University of Science and Technology  
E-mail: [wjlay@mail.mcut.edu.tw](mailto:wjlay@mail.mcut.edu.tw)

<sup>2</sup> Dept. of Electronic Engineering, Lunghwa University of Science and Technology  
E-mail: [ginggle@mail.lhu.edu.tw](mailto:ginggle@mail.lhu.edu.tw)

## ABSTRACT

This study discusses the application of frequency band design for monopole antenna to 3.5GHz WiMAX and 2.425GHz WLAN and Bluetooth communication. The foremost function of antennas is to convert the radiated electromagnetic wave energy in the transmission medium (generally air medium) and the energy sent from or received by the transceiver. The Bluetooth is a low cost, low power and short distance wireless communication technology, it can be extensively used in mobile communication equipments. This study uses Ansoft HFSS electromagnetic simulation software to simulate the 3D radiation field pattern, current distribution, gain value and Return Loss pattern of antenna, to design Bluetooth and WiMAX antennas with center frequency of 2.425G Hz and 3.5G Hz and reflection loss smaller than -10dB, which are fabricated on FR4 substrate successfully. As there are errors between the simulation and measured values, the required effect of antenna can be implemented by continuous simulation.

**Keywords:** single-band; coplanar antenna; WiMAX; WLAN; Bluetooth

## 1. INTRODUCTION

The antenna is indispensable to wireless communication products, and the quality of antenna determines whether the wireless communication products have good transmission power and receiving sensitivity. At present, the wireless communication products are frequently used in our daily life, such as smart phone, satellite navigation (GPS), the broadcast in daily life, the file transmission Bluetooth and so on, involving a wide range of frequencies. There are multiple forms of antenna, such as microstrip antenna [1], printed antenna [2] and PIFA [3].

There are different types of design of microstrip antenna, such as loop antenna, slot antenna [4], patch antenna [5] and inverted F antenna, the design and application can be implemented according to different characteristics, such as length, thickness, shape, size and weight. In

terms of electrical property, the radiation pattern, bandwidth [6], direction of polarization, gain, return loss and SWR of antenna must be considered.

## 2. ANTENNA SUMULATION STEPS

This study uses simulation, test and modification for design, so as to make the theoretical values coincident with the actual values, and the Ansoft HFSS software adopted has been extensively used in the circle and academia. Therefore, when the Ansoft HFSS is used, if the structure, parameters and material meet the design conditions, the measuring basis will be very close to the simulation results. The simulation process is described below.

### (1) Build antenna structure:

The antenna structure is drawn according to the models provided by Ansoft HFSS.

### (2) Define boundary conditions:

Ansoft HFSS uses boundary condition setting function, the antenna conductor face can be defined as PEC (Perfect Electric Conductor) or Finite Conductor, both are conductor characteristics. The former one is perfect and the latter one is finite conductor. The finite conductor can adjust the electrical conductivity and relative permeability of antenna conductor face, multiple conducting materials can be defined.

### (3) Set feed-in method:

The selection and setting of feed-in method are one of key factors in the analysis of antennas by Ansoft HFSS. There are two common feed-in methods for antennas, which are Lump Port and Wave Port. However, the Lump Port is usually used for Microstrip Line feed-in, the feed-in method for this simulation is Wave Port.

### (4) Set free radiation field conditions:

Ansoft HFSS often aims at open structures, e.g. antenna scattering problem, the Radiation or PML (Perfectly Matched layer) is usually used for calculation. The Radiation requires a large space, the simulation analysis time is much longer than PML, and there is slight difference in the simulated result. Therefore, the radiation field condition is set as PML, the simulation analysis time can be shortened greatly, and the radiation

field condition can be set as Radiation when the final result is obtained, so as to obtain relatively accurate result.

(5) Set simulation parameters:

Ansoft HFSS sets the antenna analysis simulation parameters. First, the Solution Frequency is set, and then the Adaptive Solutions are set, which shall be increased if the convergence fails after simulation analysis. Afterwards, the scanning frequency is set as Fast, Discrete or Interpolation, and then the range of scanning frequency is set before simulation analysis.

(6) Simulation analysis:

Therefore, the Ansoft HFSS provides a Validation Check after the settings are completed, so as to check if there are errors in the parameters and materials before simulation.

(7) Judge convergence:

After the Ansoft HFSS analysis is completed, the overall analysis is observed and the convergence is judged according to the Solution Data. The last value of Adaptive Solutions must be smaller than the maximum convergence function, representing convergence.

(8) Simulation results:

Finally, the S-parameter and 3D radiation field pattern about antenna are extracted.

### 3. ANTENNA DESIGN AND MEASURE

This study discusses the application of frequency band design of monopole antenna to 3.5GHz WiMAX and 2.425GHz WLAN and Bluetooth communication. Figure 1 shows the design size and structure of the single frequency antenna, the center frequency of the single band antenna is 3.5G Hz.

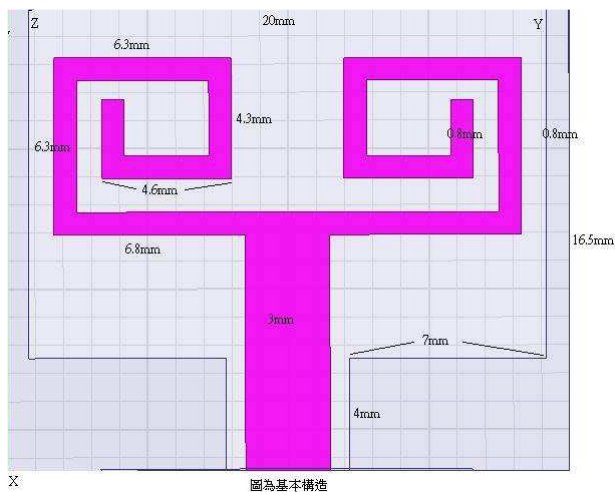

Fig. 1 Design a single band antenna with center frequency of 3.5G Hz, the size parameter and structure are obtained by simulation.

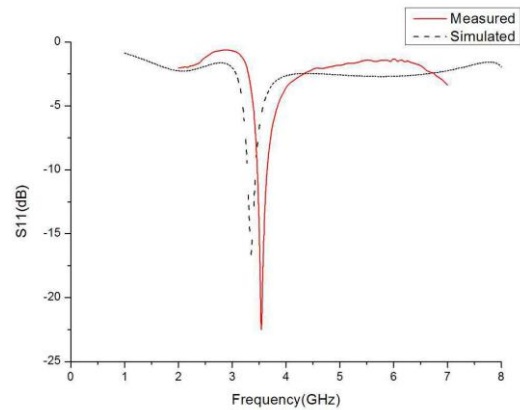

Fig. 2 Simulates and measures the single band antenna with center frequency of 3.5G Hz

Figure 2 simulates and measures the single band antenna with center frequency of 3.5G Hz, the return loss is less than -10dB, the bandwidth range is 3.44~3.69GHz. Figures 3 and 4 simulate the radiation patterns of single band antenna with center frequency of 3.5G Hz on XZ plane and YZ plane.

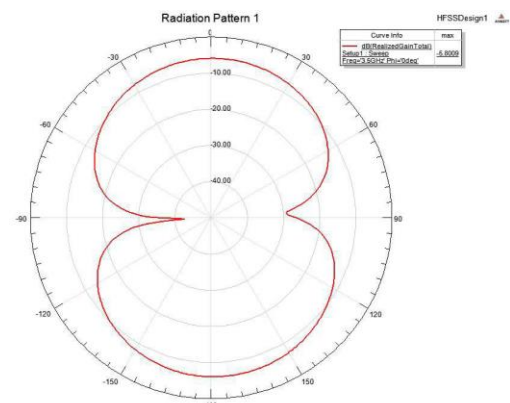

Fig. 3 Simulate the radiation patterns of single band antenna with center frequency of 3.5G Hz on XZ plane.

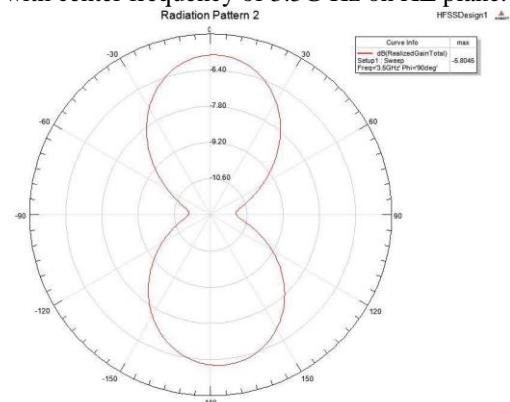

Fig. 4 Simulate the radiation patterns of single band antenna with center frequency of 3.5G Hz on YZ plane.

Figures 5 and 6 measure the radiation patterns of single band antenna with center frequency of 3.5G Hz on XZ plane and YZ plane. Figure 7 shows the antenna current distribution. Figure 8 shows the real completed antenna.

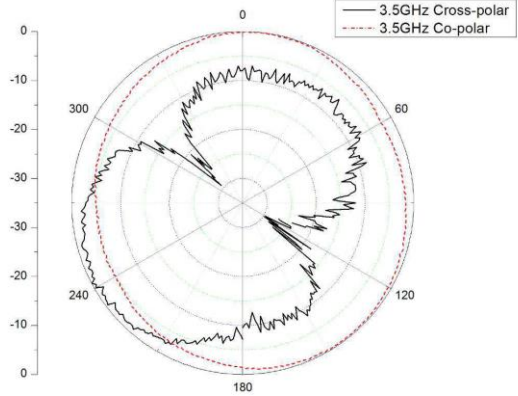

Fig. 5 Measure the radiation patterns of single band antenna with center frequency of 3.5G Hz on XZ plane.

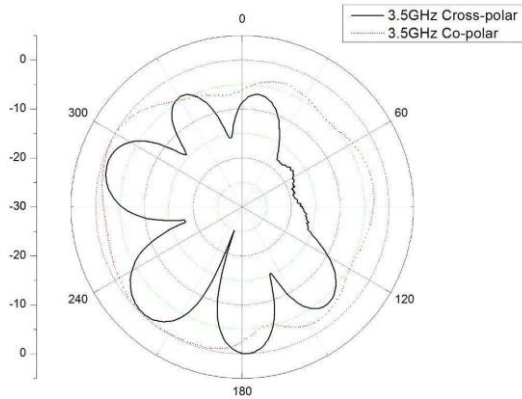

Fig. 6 Measure the radiation patterns of single band antenna with center frequency of 3.5G Hz on YZ plane.

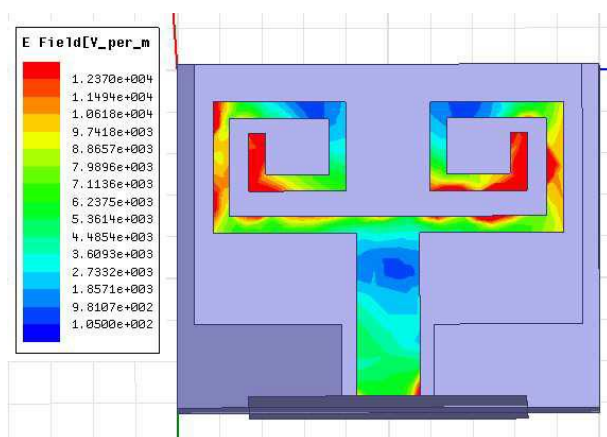

Fig. 7 The antenna current distribution.

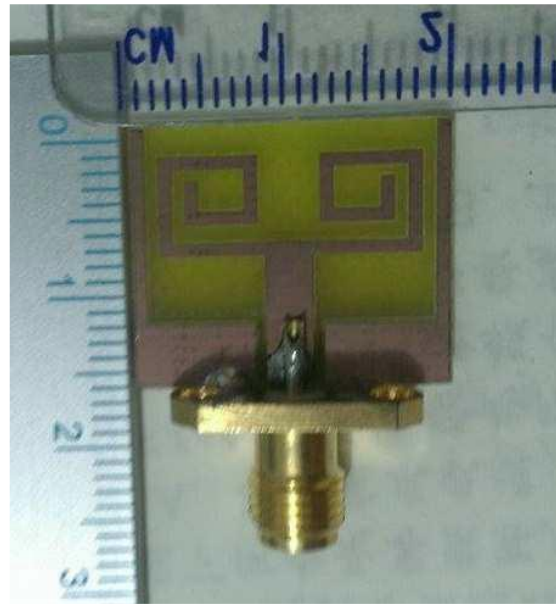

Fig. 8 The real completed antenna.

Afterwards, the size of the antenna structure on center frequency of 3.5GHz is adjusted slightly, as shown in Figure 9, to design a single band antenna with center frequency of 2.425G Hz, the size parameter and structure are obtained by simulation.

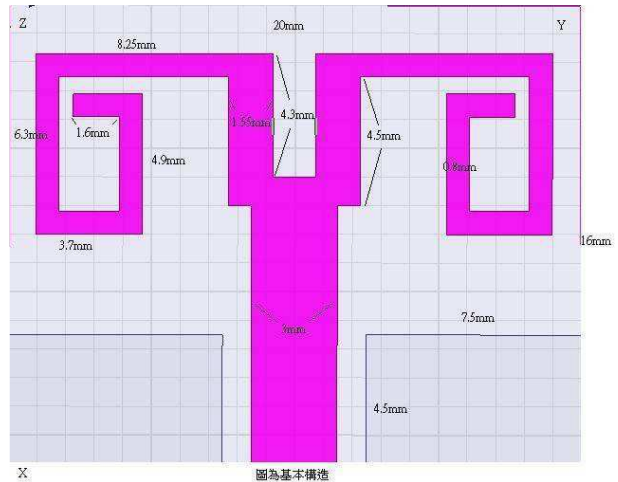

Fig. 9 Design a single band antenna with center frequency of 2.425G Hz, the size parameter and structure are obtained by simulation.

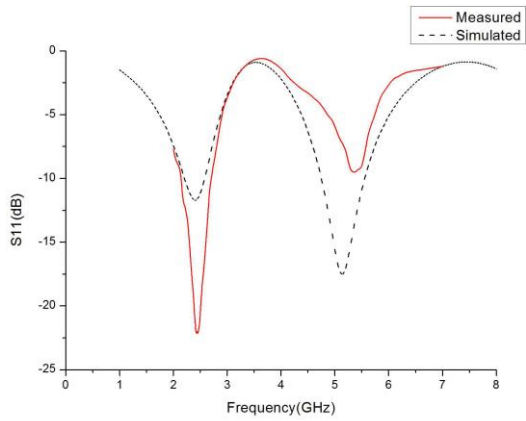

Fig. 10 Simulates and measures the single band antenna with center frequency of 2.425G Hz.

Figure 10 simulates and measures the single band antenna with center frequency of 2.425G Hz, the return loss is less than -10dB, the bandwidth range is 2.40~2.484GHz. Figures 11 and 12 simulate the radiation patterns of single frequency antenna with center frequency of 2.425G Hz on XZ plane and YZ plane.

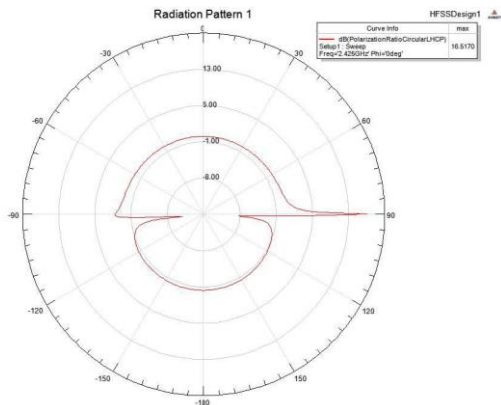

Fig. 11 Simulate the radiation patterns of single band antenna with center frequency of 2.425G Hz on XZ plane.

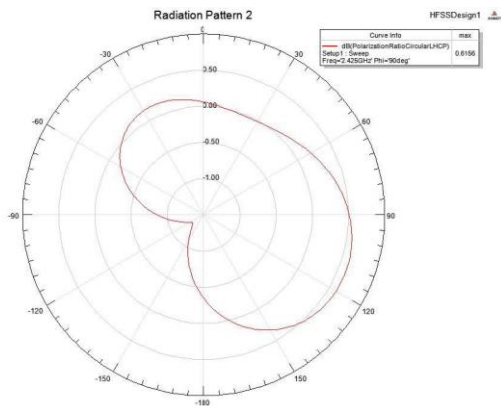

Fig. 12 Simulate the radiation patterns of single band antenna with center frequency of 2.425G Hz on YZ plane.

Figures 13 and 14 measure the radiation patterns of single band antenna with center frequency of 2.425G Hz on XZ plane and YZ plane. Figure 15 shows the antenna current distribution. Figure 16 shows the real completed antenna.

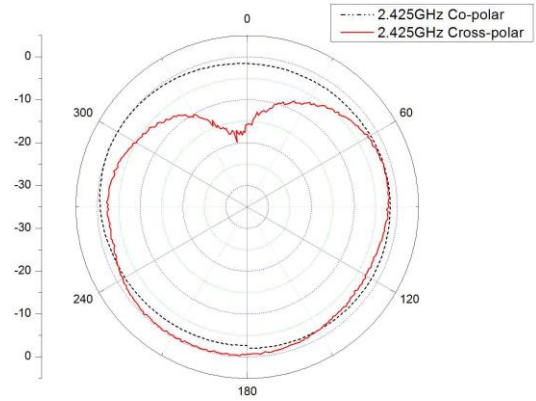

Fig. 13 Measure the radiation patterns of single band antenna with center frequency of 2.425G Hz on XZ plane.

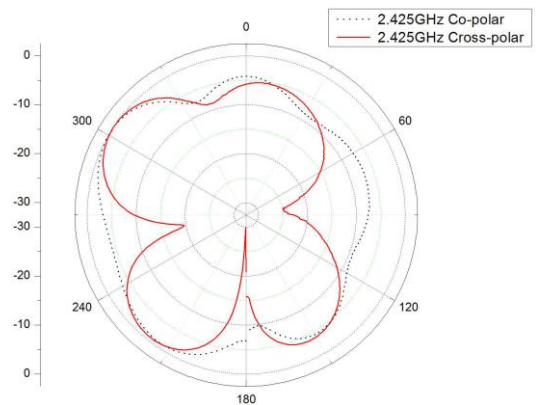

Fig. 14 Measure the radiation patterns of single band antenna with center frequency of 2.425G Hz on YZ plane.

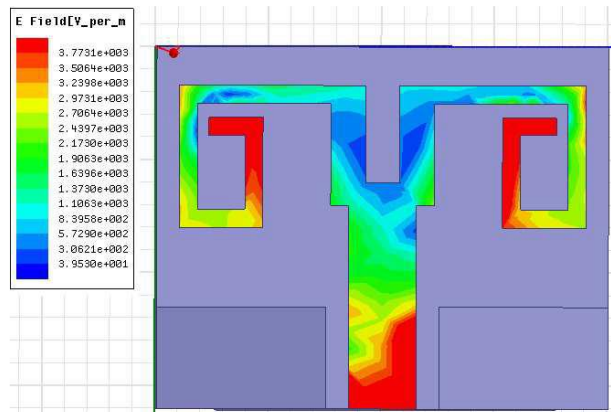

Fig. 15 The antenna current distribution.

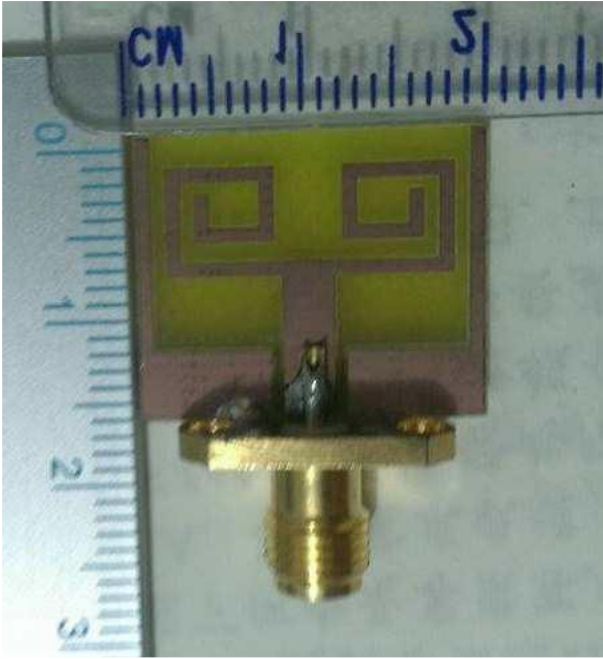

Fig. 16 The real completed antenna

#### 4. CONCLUSION

This study uses electromagnetic software (Ansoft HFSS) simulation design for 3.5GHz WiMAX and 2.425GHz WLAN single band coplanar antenna, and the antenna is fabricated on the glass fiber board (FR4) successfully. According to the simulation and measurement of return loss, radiation field pattern and current distribution, the frequency ranges of the two antennas of different frequency bands are 3.44~3.69GHz and 2.40~2.484GHz, and the simulation and measurement results are similar to each other.

#### REFERENCES

- [1] Pozar, D.M., "Microstrip Antennas", Proceedings of the IEEE, vol. 80, pp. 79-91, Jan. 1992.
- [2] Seong Youp Suh, Warren L. Stutzman, and William A. Davis "A new ultra wideband printed monopole antenna : the planar inverted cone antenna ( PICA ) " Antennas and Propagation, IEEE Transactions on, Volume: 52, pp. 1361-1364, Issue: 5, May 2004.
- [3] C. R. Rowell and R. D. Murch, "A compact PIFA suitable for dualfrequency 900/1800-MHz operation," IEEE Trans. Antennas Propagat., vol. 46, pp. 596—598, Apr. 1998.
- [4] H. Ayad, M. Fadlallah, H. Youssef, H. Elmokdad, F. Ndagijimana, and J. Jomaah, "Performances of low profile dipole antenna AMC-based surface using metamaterials structures, "International Conference on Telecommunications (ICT), pp. 1-5, 2012.
- [5] Zhang, X.W., Shi, J. and Tong, M.S., "Tunability analysis of a miniaturized patch antenna with self-biased magnetic film, "IEEE International Conference on Computational Electromagnetics (ICCEM), Hong Kong, pp. 166 – 168, 2015.
- [6] Le Trong Trung and Nguyen Quoc Dinh, "A proposal of a compact Ultra-Wide Band antenna works as a magnetic dipole, "International Conference on Advanced Technologies for Communications (ATC 2014) , pp. 577 – 581, 2014.