



Managing an Epidemic with Economic Costs and Population's Non-Compliance in Mind

Zhandos Dauzhanov, Leonard Braun, João Rei, Ebru Gül,
Christina Kuttler and Joachim Draeger

EasyChair preprints are intended for rapid dissemination of research results and are integrated with the rest of EasyChair.

September 16, 2024

Managing an Epidemic with Economic Costs and Population's Non-Compliance in Mind

Zhandos Dauzhanov, Leonard Braun, João Rei, Ebru Gül, Christina Kuttler¹,
and Joachim Draeger²

¹ Technical University of Munich, Department of Mathematics

kuttler@ma.tum.de

² IABG mbH, Ottobrunn

draeger@iabg.de

Abstract

The COVID-19 pandemic has shown that managing interventions involves more than just preventing new infections. The government has to take into account e.g. economic losses resulting from increased countermeasures and the mood of the population into account as well. Unfortunately, up to now only very few epidemic models integrate such cross-domain effects.

The paper presents a compartmental epidemiological model enhanced by psychological aspects. These aspects may influence the behavior of the population in response to epidemic conditions and governmental actions. The model incorporates frictions for being more realistic. The assessment of the epidemic's economic impact takes the incapacitated workforce due to both illness and lockdown regulations into account. The reproduction of fundamental economical and psychological effects occurring in an epidemics situation validates the chosen modeling approach.

Due to the limited availability of real-world data concerning psychology and economy, it was not possible to execute a model calibration. Thus, several model parameters have been chosen based on educated guesses. This restricts the usefulness of the model for quantitative predictive purposes. The paper concludes with a discussion and an outlook.

1 Introduction

Throughout human history, various disease outbreaks have incurred significant costs, both in terms of human lives and economic losses. Examples are Spanish flu, typhus, plague, Ebola, cholera, swine flu, avian flu and, recently, COVID-19. In 2015, Bill Gates [1] warned of the potentially catastrophic consequences of such outbreaks, followed by a more detailed elaboration [2] in course of the COVID-19 pandemic. As of 1-st June 2024, COVID-19 has resulted in the loss of 7,010,681 lives worldwide [3] and has had a massive negative impact on the global economy [4]. One of the most devastating pandemics in history, the Spanish flu, claimed between 50 to 100 million lives [5].

Mitigating the consequences by intervention management is no easy task due to various complications. Here, we want to focus on the influence of the mood of the population and of economical aspects. For this purpose, we will use an SEIR model for representing epidemics itself. The model is extended by the compartments of hospitalized individuals and individuals in a critical condition, since a large number of people in such a condition influences the mood of the overall population significantly. Dependent on its mood, the population may or may not adhere to the intervention regulations raised by the government, i.e. by the control unit.

For assessing the readiness of the population to follow intervention regulations based on its actual mood, a score function is used. A control unit decides on tightening or relaxing

the countermeasures against the epidemic based on the value of this score function. As in [6], modifying the intervention regulations — i.e. the countermeasures being in effect — is represented by adjustment of the corresponding model parameters.

To study the readiness of the population to comply, the model tracks the psychological state of the population. Assessments of both the government’s previous actions and the current situation by the population are taken into account. In this respect, recent developments are considered as being far more significant than those in the distant past. Additionally, the level of vaccination corresponds to the level of compliance to the countermeasures. The economic impact of the epidemic results from the number of individuals incapacitated due to illness and the severity level of the imposed lockdown.

The structure of the paper is as follows: Section 2 reviews related work. In Section 3, we introduce the proposed epidemic model along with the psychology- and economics-related extensions. Section 4 analyzes the behavior of the model and validates it concurrently. In Section 5, the limitations of the model and potential improvements are discussed. The paper concludes with a summary of results in section 6.

2 Related Work

The SIR (Susceptible, Infected, Recovered) model of epidemics has been the basis for understanding epidemic dynamics. The paper of Zurek et al. [6] extends such compartmental models with inclusion of imperfections, such as delays and observational errors. A general theoretical framework for assessing the consequences of frictions is presented in [7, 8]). We will now indicate some papers, which are relevant for the psychological and economical model extensions.

2.1 Psychological Sub-model

To control an epidemic, it is crucial to understand how the population reacts to the countermeasures [9]. Important papers regarding public perception, trust in the government, and behavioral adaptations are:

Public Opinion and Misinformation: Fischer et al. [10] (and, more detailed, [11]) incorporate an information diffusion sub-model. In this way, they demonstrate that misinformation can significantly impact the effectiveness of countermeasures. A much more general model of human cognition with inclusion of psychological biases and errors is presented in [12]. Though focusing on social engineering, this model may be applicable to epidemics as well.

Trust in Government: The level of trust in the government influences the degree to which the population complies with the countermeasures [13]. Rieger and Wang [14] specify the factors impacting government trust, such as transparent communication, perceived competence, and fairness of the government. A key finding of this work is that greater confidence in government action during the COVID-19 pandemic was associated with better compliance with countermeasures and lower infection rates. The comparison [15] of Sweden and Denmark shows that Denmark’s more strict pandemic management led to higher public trust in the government. Sweden’s more indulgent approach led to lower trust and greater public criticism.

Behavioral Change and Compliance : Acuna-Zegarra et al. [16] use a time-varying transmission rate. According to [16], public compliance could significantly reduce the need for an extended lockdown. Another study [17] explores the relationship between stringency of measures and non-compliance of population. A formal measure for quantifying the stringency can be found in [17].

2.2 Economic Sub-model

The economic costs of epidemic countermeasures are another important assessment measure of epidemics management. The papers [18, 19] underline the sensitivity of the GDP (Gross Domestic Product) to public health interventions. While [20, 21] explore the relationship between COVID-19 countermeasures and their economic impacts, [22] takes it a step further by examining this relation for specific job groups and geographical regions. For [20, 21, 22], countermeasures have to be balanced to ensure that both public health and economic benefits are realized. These papers give insight into the epidemic-economic trade-off and indicate consequences of different intervention strategies.

Silva et al. [23] use an agent-based model (COVID-ABS) instead of an SEIR model for analyzing the economic impact of an epidemic. [18] highlights the economic disruptions caused by a lockdown. Further studies such as [24, 25, 26] discuss the economic impact of outbreaks in terms of historical context. [27] is written from the perspective of business history.

3 Model definition

In the following, we introduce the underlying epidemic model, the components for the psychological and the economic effects as well as the control unit approach for the countermeasures.

3.1 The SEIRHCD Model

For describing the epidemiological dynamics, we use an extension of the classical SEIR-model [28]. The population is divided into seven compartments: Susceptible S , exposed E , infected I , recovered R , hospitalized H , being in critical condition C and deceased D . Susceptible individuals can become exposed (E) at a rate of β upon contact with infectious individuals. Once exposed, they become infectious at a rate of α and move into compartment I . They then recover at a rate of γ . With probability $1 - p_a$, an infectious person is hospitalized. Upon hospitalization, there is a probability of p_c that the condition becomes critical, and that the

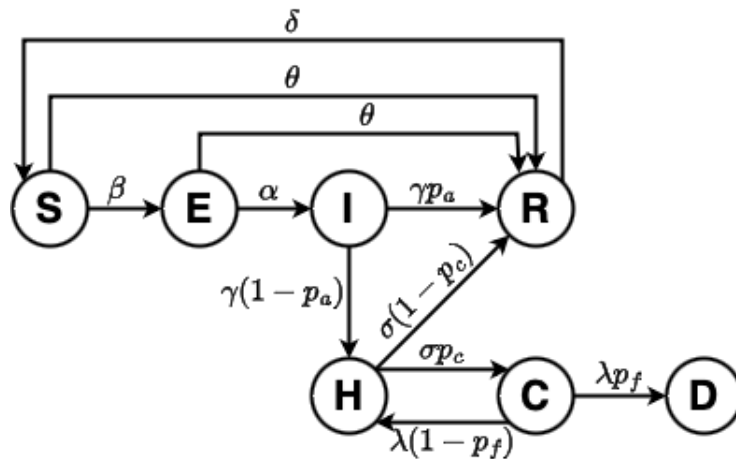

Figure 1: Flowchart of the SEIRHCD epidemic model (1)

person needs to be transferred to an ICU (intensive care unit). With a probability of $1 - p_c$, the hospitalized individual recovers with rate σ . People in critical condition cannot recover. With a rate λ , the individual goes back to H with probability $1 - p_f$ or it dies with probability p_f . Recovered individuals lose their immunity at rate δ .

The rate θ of vaccination depends linearly on the non-compliance variable A introduced in section 3.3. The minimal vaccination rate is designated as θ_0 . The scale of influence of A on θ is given by the parameter k . Vaccination is represented by a flow from susceptible S and exposed E individuals to recovered R individuals. The population size $N = S + E + I + H + C + R + D$ is thus considered as being constant.

Parameters of the model with values for the Covid 19 case		
Parameters	Values	Meaning
$\alpha \in \mathbb{R}^+$	0.3	Rate of being infected
$\beta \in \mathbb{R}^+$	0.05	Transmission rate
$\gamma \in \mathbb{R}^+$	0.01	Rate of leaving the state ‘infectious’
$\delta \in \mathbb{R}^+$	0.0055	Rate of becoming susceptible again after recovery
$\theta_0 \in \mathbb{R}^+$	0.01	Minimum vaccination rate
$k \in \mathbb{R}^+$	0.002	Level of influence of non-compliance A on the vaccination rate
$\sigma \in \mathbb{R}^+$	0.5	Rate of leaving the state ‘hospitalized’ (either by recovery or transfer to the ICU)
$\lambda \in \mathbb{R}^+$	0.5	Rate of leaving the state ‘being in critical condition’ (by becoming hospitalized or by dying)
$p_a \in [0, 1]$	0.79	Fraction of infectious individuals, which do not need hospital treatment
$p_c \in [0, 1]$	0.12	Fraction of hospitalized individuals being transferred to an ICU
$p_f \in [0, 1]$	0.33	Fraction of critical cases resulting in death

Table 1: Parameters with values of the SEIRHCD model (1)

The following ODE system describes the model illustrated in figure mathematically. Table 1 gives a list of the parameters.

$$\begin{aligned}
\frac{dS(t)}{dt} &= -\frac{\beta S(t)I(t)}{N} + \delta R(t) - \theta S(t) \\
\frac{dE(t)}{dt} &= \frac{\beta S(t)I(t)}{N} + \alpha E(t) - \theta E(t) \\
\frac{dI(t)}{dt} &= \alpha E(t) - \gamma I(t) \\
\frac{dH(t)}{dt} &= \gamma(1 - p_a)I(t) + \lambda(1 - p_f)C(t) - \sigma H(t) \\
\frac{dC(t)}{dt} &= \sigma p_c H(t) - \lambda C(t) \\
\frac{dR(t)}{dt} &= \gamma p_a I(t) + \sigma(1 - p_c)H(t) - \delta R(t) + \theta(S(t) + E(t)) \\
\frac{dD(t)}{dt} &= \lambda p_f C(t),
\end{aligned} \tag{1}$$

where $\theta = \theta(A) = \theta_0 + k\frac{A}{M}$. The parameters $\alpha, \beta, \gamma, \delta, \theta_0, \sigma, \lambda$ have the unit days^{-1} . The probabilities p_a, p_c, p_f are unitless as well as the parameter k .

3.2 Control Unit

Various countermeasures may influence the evolution of an epidemic by modifying the values of specific parameters in (1). For example, the infection rate β is reduced as a consequence of social distancing or wearing masks. The countermeasures are raised by a control unit, which evaluates the actual situation and decides about necessary actions. Large numbers of new infections may trigger additional countermeasures, whereas an improvement of the situation may lead to a release of active countermeasures. We assume that the control unit is subject to an observation error concerning the number of new infections.

Definition 3.1. *The control unit assesses the epidemic situation based on a score function*

$$\Phi_{CU}(t; \omega_I, \omega_H, \omega_C, \omega_D, \varepsilon) = \frac{\varepsilon\omega_I I'(t) + \omega_H H'(t) + \omega_C C'(t) + \omega_D D'(t)}{\omega_I + \omega_H + \omega_C + \omega_D},$$

where $\omega_I, \omega_H, \omega_C, \omega_D \in \mathbb{R}^+$ are compartment weights and $\varepsilon \in [0, 1]$ is the observation correctness. The actual case number is equal to I whereas the number of observed cases is given by εI . Low observation correctness thus results in underestimating the severity of the epidemic situation [29]. When the score function $\Phi_{CU}(t)$ exceeds thresholds

$$0 < T_1 < T_2 < T_3 \leq 1,$$

countermeasures will be set into effect, which reduce the transmission rate β by multiplication with the corresponding efficiency coefficient

$$0 < \eta_3 < \eta_2 < \eta_1 < 1.$$

When the population is fully compliant and when the i -th countermeasure is in effect, the effective transmission rate is given by $\eta_i \beta < \beta$. Since a smaller η means more strict countermeasures, η_i could be seen as a kind of measure of the strictness of the countermeasures. The release of countermeasures is possible as well. The release thresholds are pairwise smaller than the activation thresholds.

$$0 \leq \tilde{T}_1 < \tilde{T}_2 < \tilde{T}_3 < 1 \quad \text{with} \quad \tilde{T}_i < T_i.$$

In order to deal with the different orders of magnitude of I', H', C', D' , the values of I', H', C' and D' are scaled by coefficients q_I, q_H, q_C and q_D , respectively, allowing now an interpretation as capacities. If we assume for example $q_C = 0.001$ as capacity of ICU beds, a value of $C' = 0.0007$ would result in $0.0007/0.001 = 0.7$ and thus in 70% of the available capacity. We use the values $q_H = 0.003$, $q_C = 0.0003$ [30] and $q_I = 0.1$, $q_D = 0.1$ based on simulations and [6].

3.3 Psychological Effects

Countermeasures may not achieve their full potential due to non-compliant individuals. They may e.g. perceive the countermeasures as excessive compared to the actual danger of the epidemic situation. Accordingly, we apply a scaling factor $A(t) \in [0, 1]$ representing the level of non-compliance of the population. If $A = 0$, the population is fully compliant and the countermeasure achieves its maximum effectiveness. Conversely, $A = 1$ indicates a completely non-compliant population; the countermeasures do not have any effect then. The non-compliance

$A(t)$ depends on how the population perceives the control unit's performance in the past. If the regulations in the past were considered as adequate, the population trusts the current regulations. However, if the countermeasures are perceived as too strict, the population is likely to be less willing to comply with them. This will typically increase the effective transmission rate later on.

Definition 3.2. *The population assesses the situation analogous to the control unit using a score function Φ_{pop} . The form of Φ_{pop} corresponds to Φ_{CU} , but we are using different weights $\kappa_I, \kappa_H, \kappa_C, \kappa_D \in \mathbb{R}^+$. Note that the derivatives I', H', C', D' include the scaling quotients q_I, q_H, q_C, q_D as in case of the control unit:*

$$\Phi_{pop}(t; \kappa_I, \kappa_H, \kappa_C, \kappa_D, \varepsilon) = \frac{\varepsilon \kappa_I I'(t) + \kappa_H H'(t) + \kappa_C C'(t) + \kappa_D D'(t)}{\kappa_I + \kappa_H + \kappa_C + \kappa_D}.$$

The level of non-compliance of the population is given by the differential equation

$$\dot{A}(t) = M \left(\int_{-\infty}^t \max(0, (1 - \eta(s) - \Phi_{pop}(s)))^3 \omega(t - s) ds + A(0) - A(t) \right). \quad (2)$$

The integral term represents the 'memory' of the population, whereas the parameter $M > 0$ determines how quickly A adapts. The function $\eta(s) \in \{0, \eta_3, \eta_2, \eta_1\}$ denotes the countermeasures in effect at time s . The parameter $A(0)$ is the initial non-compliance level, which can be seen as an overall ideological tilt. In case of $1 - \eta > \Phi_{pop}$, the integral term is positive leading to an increase of A . The function

$$\omega(t - s) = b \exp(-b(t - s)).$$

assures that more recent events are more important than those long ago. The parameter $b > 0$ controls how fast the memory is evading. Then, the effective transmission rate β_{eff} is given by

$$\beta_{eff}(t) = \beta(\eta(t) + (1 - \eta(t))A(t)). \quad (3)$$

For dealing with the integral term in (2), we introduce an auxiliary variable

$$B(t) := \int_{-\infty}^t \max(0, (1 - \eta(s) - \Phi_{pop}(s))) \omega(t - s) ds. \quad (4)$$

Due to $\frac{\partial \omega}{\partial t} = -b^2 \exp(-b(t - s)) = -b\omega$, Leibniz Integral rule gives

$$\begin{aligned} \dot{B}(t) &= -b \int_{-\infty}^t \max(0, (1 - \eta(s) - \Phi_{pop}(s))) \omega(t - s) ds + b \max(0, (1 - \eta(t) - \Phi_{pop}(t))) \omega(0) \\ &= -b (B + \max(0, 1 - \eta(t) - \Phi_{pop}(t))). \end{aligned}$$

In order to avoid a numerical evaluation of the integral, we include the auxiliary variable in the system (1) of ODEs

$$\begin{aligned} \dot{A} &= M(mB - A) \\ \dot{B} &= -bB + b \max(0, (1 - \eta(t) - \Phi_{pop}(t))), \end{aligned}$$

which is easier to calculate than a straightforward evaluation of the expression (2).

3.4 Consequences on Economics

From the viewpoint of pure epidemics, an ongoing strict lockdown is always preferable as it clearly minimizes the overall number of infections. However, such countermeasures come at economical costs. The closure of restaurants, the prohibition of major events, the imposition of curfews and the enforcement of quarantine are causing significant economical costs [31]. There exists a trade-off between preserving economy and reducing the case numbers. The economic output may not only be affected by countermeasures, though; it can also be influenced by the decline in the workforce caused by infections. Let $C_e(t)$ designate the economic costs. They depend on the fraction of the population unable to work, so both the number of infected persons and the stringency of the countermeasures (e.g. lockdown and social distancing) need to be taken into account. The effect of these two factors may be quite different — a sick person can no longer work at all, but a person working from home can do so very well. The overall costs result from integrating $C_e(t)$ along the duration of the entire epidemic.

Definition 3.3. *The economic impact of the reduction in workforce is given by the integral of the product of a functions f dependent on the workforce $S(t) + R(t)$ and a functions g dependent on the the stringency $\eta(t)$ of countermeasures. These functions each have the purpose of assessing the economic impact of a reduced workforce. This gives:*

$$C_e := \int_0^{t_f} f(\eta)g(S + R)dt, \quad (5)$$

with sigmoid-type functions f, g :

$$\begin{aligned} f: [0, 1] &\rightarrow [0, 1]; & \eta &\mapsto (1 + \exp(-k_\eta(\log(\eta^{-1} - 1) - f_0)))^{-1} \\ g: [0, 1] &\rightarrow [0, 1]; & S + R &\mapsto (1 + \exp(-k_I(\log((S + R)^{-1} - 1) - g_0)))^{-1} \end{aligned}$$

For better readability, we have omitted above the time dependence of $\eta = \eta(t)$, $S = S(t)$ and $R = R(t)$. It holds $f(0) = 1$, $f(1) = 0$ and $g(0) = 1$, $g(1) = 0$. Both, a strict lockdown (η close to 0) and a large number of infections (small $S + R = 1 - I - H - C - D$) compromises the economical performance in equation (5). The parameters k_η, k_I determine the slope of these curves and f_0, g_0 their midpoints.

4 Model Behavior

Next we aim in checking the model behavior when including the two sub-models separately and in combination.

4.1 Psychological Sub-model

Based on equation (2) defining non-compliance, we will analyze some special cases. For simpler notation, we omit the index *pop* for the score function Φ here.

4.1.1 Perfect Compliance $A = 0$

The case $A = 0$ of ideal compliance is shown in figure 2 as well as a corresponding situation subject to non-compliance. The depicted behavior can be explained by equation (4) describing the influence of A on the transmission rate β . A more compliant population will adhere better to a lockdown. The reduced spread of the virus is indicated by the lower and earlier peak in

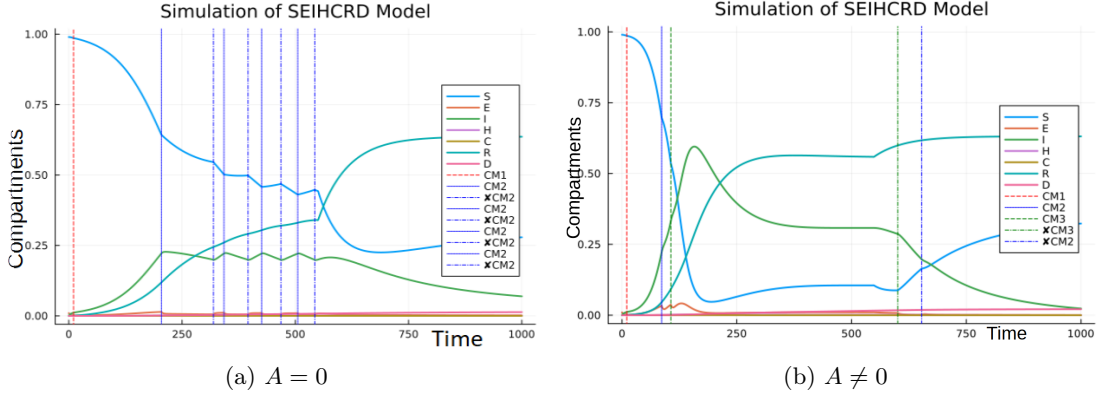

Figure 2: Left: Ideal compliance A ; Right: Non-compliance is taken into account. The vertical lines show the time points of initialising countermeasures (CM) and ending countermeasure (XCM).

the trajectory I (see figure 2a). Additionally, a non-zero A smoothes the evolution of β_{eff} due to equation (4). The roughness of the plot in figure 2a, though, is also due to the step-wise cancellation of countermeasures.

4.1.2 Excessive Countermeasures (Small η , Small Φ)

The prototypical case of non-compliance is a situation, in which the countermeasures exceed the appropriate level by far. It can be modeled with a small η (strict lockdown) and with a small Φ (harmless situation). Such an imbalance leads typically to an increasing non-compliance as can be seen in figure 3 for a mild epidemic ($\beta = 0.06$ at the beginning). In the plots shown, I has a peak of about 0.25 though it is slightly higher in case of strict countermeasures. After start of vaccination at $t = 550$, the compartment level of I decreases significantly. It stabilizes at a slightly higher level in case of less strict countermeasures, though. Insight into this behaviour gives a look at the non-compliance parameter in figure 4.

The non-compliance A grows faster and has a higher plateau for strict countermeasures, because we look at a mild epidemic. Though strict countermeasures is able to reduce the number of infections slightly compared to less strict countermeasures, the stricter response backfires in form of economic costs C_e . Since C_e depends not only on I but also on η , it is approximately 20% larger in case of strict countermeasures. The slope of the trajectory I after the start of vaccination at $t = 550$ is almost independent of η , because two effects cancel out each. While strict countermeasures lead to a small transmission rate, a smaller non-compliance increases the range of the vaccination.

If the initial non-compliance is increased to $A(0) = 0.1$, the trajectories of both I and A are significantly higher. In a population that tends to be non-compliant, imposing countermeasures in case of a relatively mild epidemic will thus show up adherence issues worsening the epidemiological situation.

4.1.3 Insufficient Countermeasures (Large η , Large Φ)

Now a serious epidemic (large Φ) with insufficient countermeasures (large η) is considered. One would expect a high level of compliance, but a disadvantageous overall situation concerning

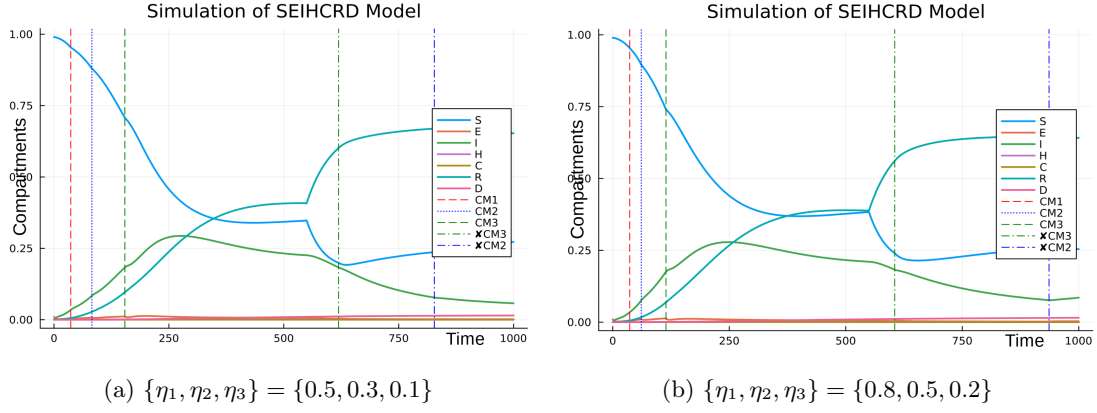

Figure 3: Consequences of strict countermeasures (left) and less strict ones (right) in case of a mild epidemic. The vertical lines show the time points of initialising countermeasures (CM) and ending countermeasure (XCM).

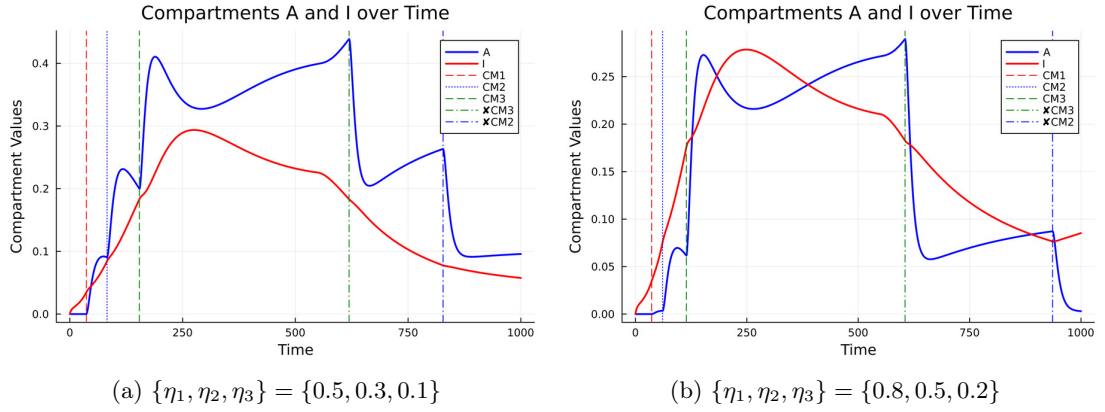

Figure 4: Non-compliance A and number I of infectious individuals for strict (left) and less strict (right) countermeasures for the situation shown in figure 3. The vertical lines show the time points of initialising countermeasures (CM) and ending countermeasure (XCM).

infection numbers, economic costs, etc. Figure 5 shows a situation with an initial effective infection rate $\beta(0) = 0.09$. The corresponding plots of the non-compliance parameter A can be seen in figure 6. Less strict countermeasures lead to a faster increase of I , as well as a slightly larger (approximately 4%) overall number. Concurrently, the non-compliance parameter A grows faster, has a higher plateau and declines slower than in the case of strict countermeasures. This might seem to be contra-intuitive, because a more serious situation may also require more strict countermeasures. Real-world data, however, support this line of argumentation (see section 4.1.5).

When we increase $A(0) = 0$ to $A(0) = 0.1$, we get the results shown in figure 7. They largely correspond to the results for a mild epidemic. Surprisingly, non-compliance A is not as large as expected in case of a serious epidemic and insufficient countermeasures. After all, if the government is under-performing, people should start to mistrust the government. Our

psychological model is unfortunately unable to represent this effect, Due to the case assumptions (large η , large Φ), the expression $\max(0, (1 - \eta(s) - \Phi(s)))^3$ in the memory term gives 0. Thus, it will not increase non-compliance. In the real-world, the mistrust may lead to an increase of non-compliance and may in effect even result in a further decline of the situation due to less effective countermeasures.

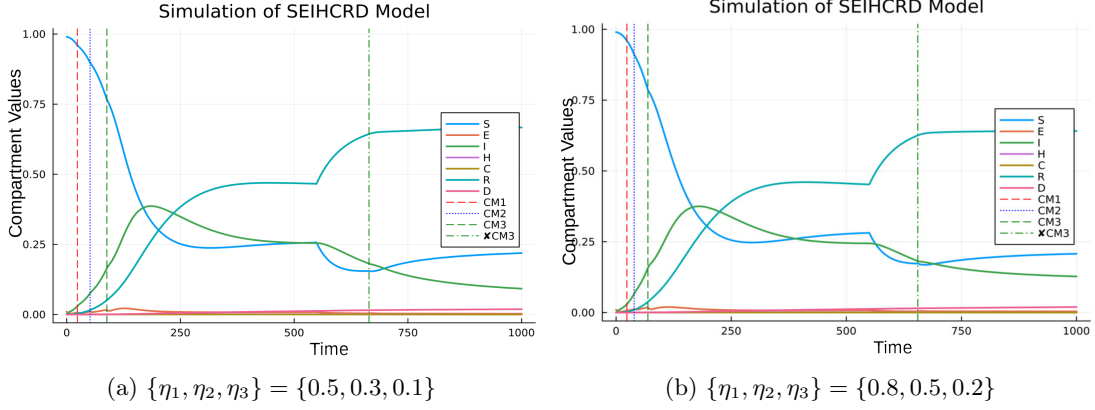

Figure 5: Consequences of strict countermeasures (left) and less strict ones (right) in case of a serious epidemic. The vertical lines show the time points of initialising countermeasures (CM) and ending countermeasure (XCM).

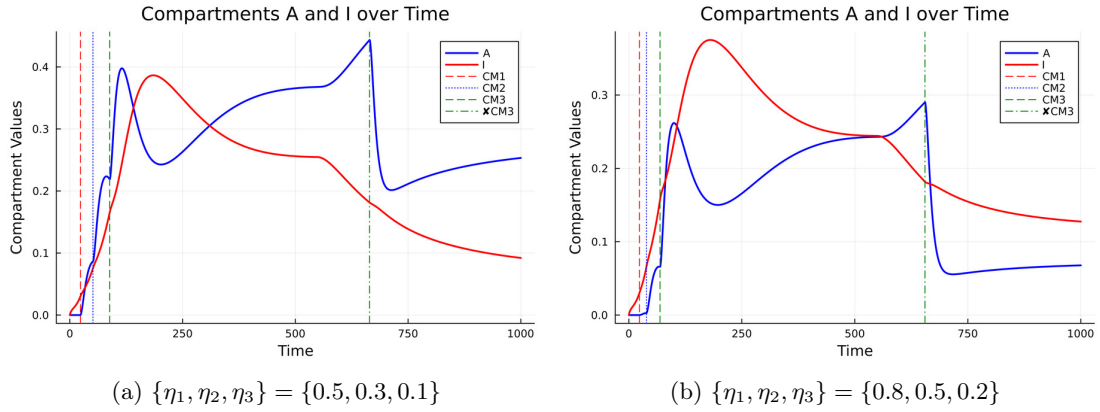

Figure 6: Non-compliance A and number I of infectious individuals for strict (left) and less strict (right) countermeasures in case of a serious epidemic. The vertical lines show the time points of initialising countermeasures (CM) and ending countermeasure (XCM).

4.1.4 The Influence of M

Typically, an epidemic will evolve as follows. Initially, there is a sharp increase in the number of infections which eventually triggers some countermeasures. This reduces β_{eff} , but it will also increase non-compliance A . The growing non-compliance finally leads to a re-increase of the transmission rate β_{eff} . If the parameter M of equation 2 is increased in the underlying

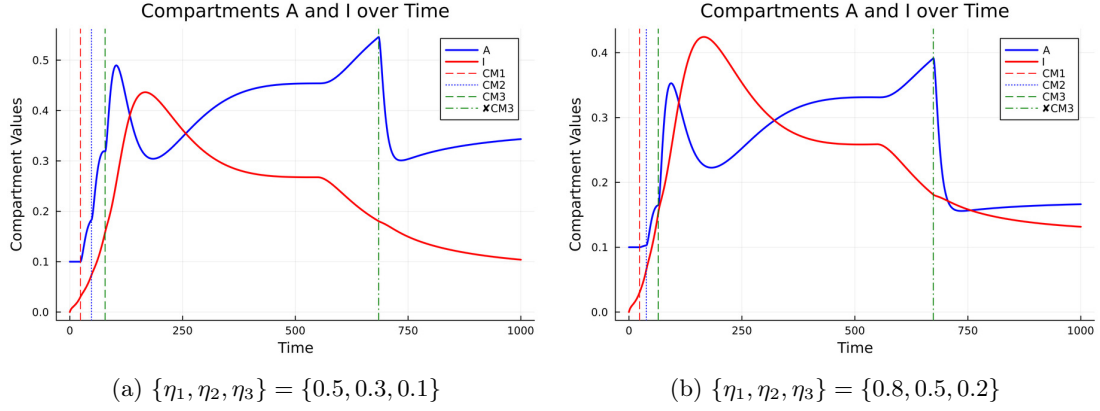

Figure 7: Non-compliance A and number I of infectious individuals for strict (left) and less strict (right) countermeasures in case of a serious epidemic and $A(0) = 0.1$. The vertical lines show the time points of initialising countermeasures (CM) and ending countermeasure (XCM).

model — as a reminder, M determines, how fast A adjusts — the depicted sequence of events may happen faster, maybe accompanied with a shift of the peak of infections to earlier times. This hypothesis is validated for the situations analyzed in figure 8.

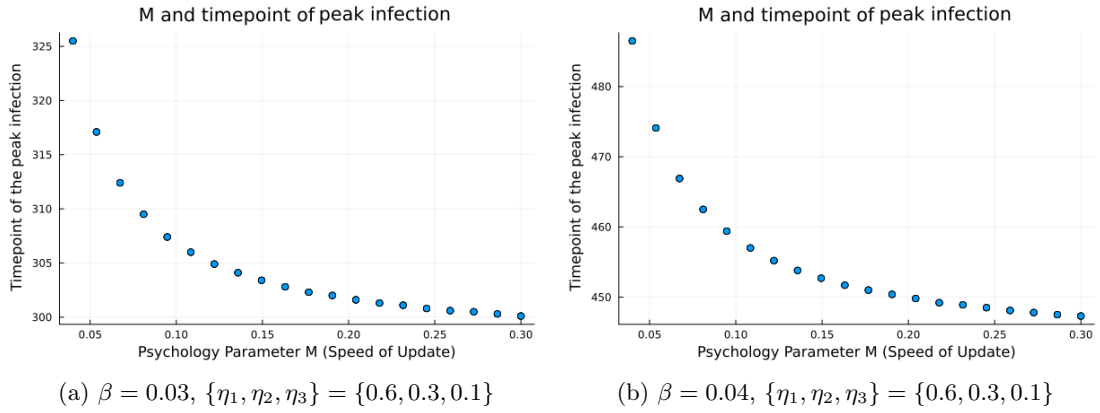

Figure 8: Position (i.e. time) of the maximum in the trajectory I dependent on M for a mild (left) and a serious (right) epidemic.

The experiments indicate that meaningful values of M cover the range $[0.05, 0.3]$. For larger values of M , the result no longer changes significantly, because A already adapts almost instantaneously. Values $M \leq 0.05$, on the other hand, lead to an increasingly unrealistic course of events. This justifies the choice of $M = 0.2$ as a standard value for our simulation runs. For the peak value of $I(t)$, we were unable to provide a general trend for $M \in [0.05, 0, 3]$. We also could not find a situation in which a feedback loop sets in between raising infection numbers and raising non-compliance of the population. For more extreme values of M , this may be different, though.

4.1.5 The Influence of Stringency on Non-compliance

In case of a serious epidemic, the population may react contra-intuitively. Given the dangerous situation, one would expect trust in the government when strict countermeasures are imposed. Real world data show [14], however, that an increased stringency¹ is associated with an increase in non-compliance in general. Perhaps, at a certain point, stricter countermeasures are associated with social consequences that are summarily considered disproportionate and inappropriate by the population, leading to a general trend of distrust towards the government.

In order to check whether this explanation is consistent with the proposed model, several simulation runs were executed. Random variation of $\alpha, \beta, \lambda, \theta$ and η represents the variety of situations in different countries. For each simulation run, the averages of the stringency $1 - \eta$ and of the non-compliance A were calculated and shown in figure 9. We see here a relationship similar to Fig.4 of [14], in which governmental regulations were judged as 'not too strong' or 'too strong' and plotted against the stringency. As [14] states, this judgement highly correlates with trust in the government and thus with our non-compliance measure A . As a side note, the plot resembles a cubic, which can be traced back to the cubed term in the memory integral (2). This connection can be used for improving the fit with real-world data by modification of this exponent.

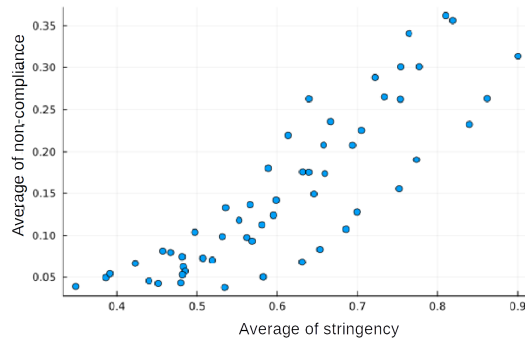

Figure 9: Relationship between stringency $1 - \eta$ and non-compliance A

4.2 Economic Sub-model

Let us consider next the influence of the economic sub-model by some simulations.

4.2.1 Cost and Deaths

As stated in [18], the economic costs may be correlated to the number of casualties. As before, several simulation runs were executed with random variation of β, M and θ for validating this hypothesis with help of our model. Let C_t be the typical total economic power of a country. The normalized loss of the economic power C_e/C_t due to the epidemic is plotted in figure 10 with regards to the total amount of deaths. The observed correlation argues for the validity of our economic sub-model.

¹A quantitative measure of stringency can be found e.g. in [17]

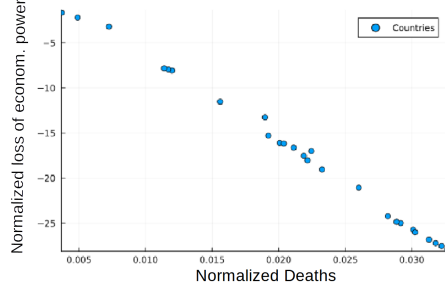

Figure 10: Loss of the normalized economical power vs. normalized number of deaths

4.2.2 Effects of a Breaking Point

In the real world, the costs of an epidemic does not depend linearly on the total number of infected people, or the stringency of the lockdown. If a large fraction of the population is unable to work, the critical infrastructure will break down at disproportional costs for the economy. Conversely, a mild epidemic may affect the economy only insignificantly. This non-linearity of C_e on η and on $I + H + C + D$ is taken into account by the auxiliary functions $f(\eta)$ and $g(S + R)$. In order to assure that appropriate parameter values have been chosen for f, g , a large number of simulation runs were executed for a given combination of k_I, g_0, k_η, f_0 with random variation of $\alpha \in [0.02, 0.04], \beta \in [0.03, 0.07], \theta_0 \in [0.002, 0.1], v \in [400, 600]$. The parameter θ_0 designates the minimum vaccination rate and v is the start time of vaccinations. Then, the results were compared to each other. A situation is 'right' iff $average_1(I + H + D + C) < average_2(I + H + D + C)$, $average_1(\eta) > average_2(\eta)$, $peakI_1 > threshold > peakI_2$ and $C_{e1} > C_{e2}$; this means that despite less people being affected in the total (smaller $I + H + D + C$ and larger η), the total cost is larger because of the higher peak of $I + H + D + C \approx I$ surpassing a certain maximum capacity. A 'right' situation corresponds to a situation with a larger peak value of I , but a lower average of both $I + H + D + C$ and $1 - \eta$.

The entire procedure was executed for different value combinations of $k_I \in \{3, 3.5, 4\}$, $g_0 \in \{0.5, 1, 1.5, 2, 2.5\}$, $k_\eta \in \{2, 2.5, 3, 3.5, 4\}$ and $f_0 \in \{-2.5, -2, -1.5, -1, -0.5\}$. We identified $\{k_I, g_0, k_\eta, f_0\} = \{3, 1.5, 4, -1\}$ as the value combination, which generates the largest number of 'right' situations. These values are thus used for the auxiliary functions f, g in the model. Being consistent with the author's expectations, a larger number of infected persons (small $S + R$) gets penalized quicker than a strict lockdown (small η). In other words, $I + H + C + D = 0.7$ lead to larger economical costs than $\eta = 0.3$ leading to a stringency of $1 - \eta = 0.7$.

4.3 Combined Analysis of Psychology and Economics

After having analysed the single effects, we want to make our approach more realistic and combine the psychological and economic effects into one model approach.

4.3.1 Economic Cost C_e , Non-Compliance A and Stringency $1 - \eta$

In order to consider both mild and serious epidemics and various interventions, the parameter values of β, θ and η were randomly varied within their plausible ranges. The result is shown in figure 11. Seemingly, the average of A and C_e/C_t as well as stringency in different countries and C_e/C_t are uncorrelated. A clear correlation, though, exists between A and η .

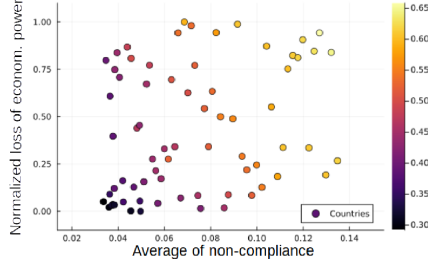
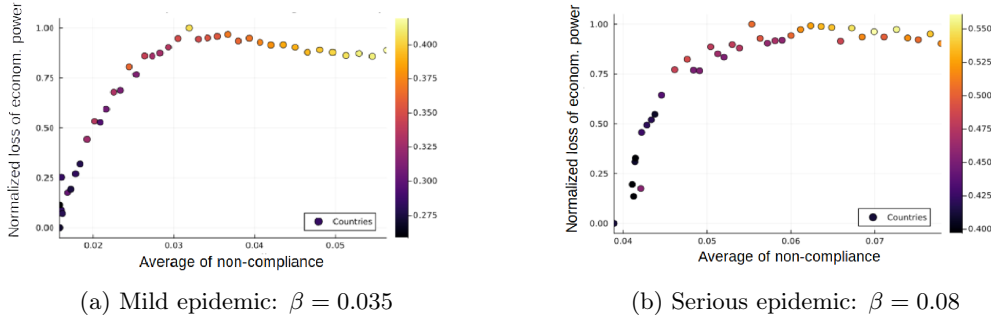

Figure 11: Scatter plot of normalized loss of economic power C_e/C_t dependent on average non-compliance A . Each dot represents an individual country. The colour of the dots indicates the average of the stringency $1 - \eta$.



(a) Mild epidemic: $\beta = 0.035$

(b) Serious epidemic: $\beta = 0.08$

Figure 12: Scatter plots of normalized loss of economic power C_e/C_t as a function of the average of A . Each dot represents an individual country. The colour of the dots indicates the average of the stringency $1 - \eta$.

The simulation runs were repeated for a fixed β , which can be considered as indicator of the severity of the epidemic. We get the plots shown in figure 12. The case of a mild epidemic in figure 12a relates to section 4.1.2. For a mild epidemic, a large stringency (small η) leads to a large non-compliance and to an unnecessary increase in economical costs. In case of a serious epidemic (see figure 12b), the situation does not seem to be substantially different.

The special case of a moderate epidemic ($\beta = 0.055$) is considered in figure 13. Up to a certain point, increasing the stringency leads to higher costs up to a certain point. Then, however, the costs C_e seem to decrease accompanied by an increase in non-compliance A as usual. This means that the more strict countermeasures result in lower overall economic costs despite of a decrease in trust by the population. This leads to the following conclusion: While countermeasures are typically detrimental in a mild epidemic and strong countermeasures are basically unavoidable in a serious epidemic, dealing with a moderate epidemics may indeed require to choose an appropriate level of stringency.

4.3.2 Economic Costs C_e and Infected Persons I

The strong correlation between stringency and non-compliance makes it advisable to check for a correlation between the normalized economical costs C_e/C_t on the total number $\int I(t)dt$ of infections. The plots in figure 14 show analogous to the previous section that more or

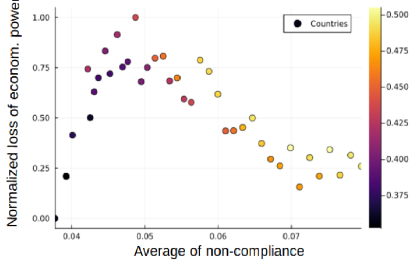

(a) Normalized loss of economic power C_e/C_t dependent on the average of A . The color of the dots indicates the average of the stringency $1 - \eta$.

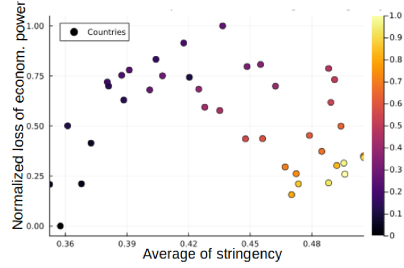

(b) Normalized loss of economic power C_e/C_t dependent on the average of the stringency $1 - \eta$. The color of the dots indicates the average of non-compliance A .

Figure 13: Costs of a moderate epidemic with non-evolving $\beta = 0.055$. Each dot represents an individual country.

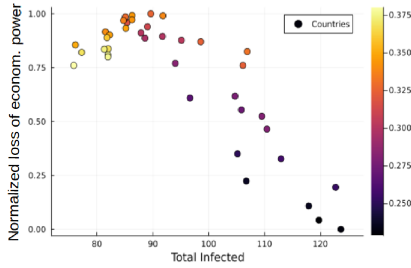

(a) Mild epidemic: $\beta = 0.03$

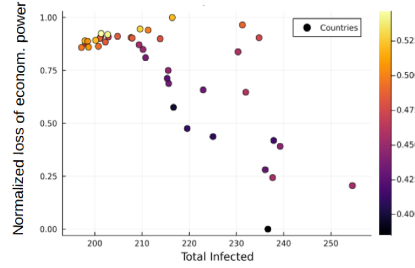

(b) Serious epidemic: $\beta = 0.075$

Figure 14: Scatter plots (with fixed β) of normalized loss of economic power C_e/C_t dependent on the total number $\int I(t)dt$ of infections. Each dot represents an individual country. The colour of the dots indicates the average of the stringency $1 - \eta$.

less independent of the seriousness of epidemics, an increasing stringency (darker to brighter colouring of the dots) is associated with a decrease of infection numbers and a rise in C_e/C_t .

Again, a moderate epidemics with $\beta = 0.057$ is considered as well (see figure 15a). We observe the already known trade-off situation. As the stringency increases, up to a certain point the total number of infections decreases but the costs C_e/C_t of the epidemics increase. After that point, however, both $\int I(t)dt$ and C_e/C_t decrease. The rising stringency is accompanied with an increase in non-compliance A . When we allow a single intervention level and look at the consequences of different values of $\eta \in [0, 1]$, the economical costs behave as shown in figure 15b. With increasing stringency $1 - \eta$, the total number of infections is at first reduced without significant economic costs; only from $1 - \eta > 0.2$ do the costs increase significantly. At $1 - \eta \sim 0.37$, the total number of infections reaches a minimum. If the stringency is increased further, both the total number of infections and the economic costs increase again. This behaviour remains more or less the same for all values of the threshold T_1 in the range $T_1 \in [0, 0.1]$.

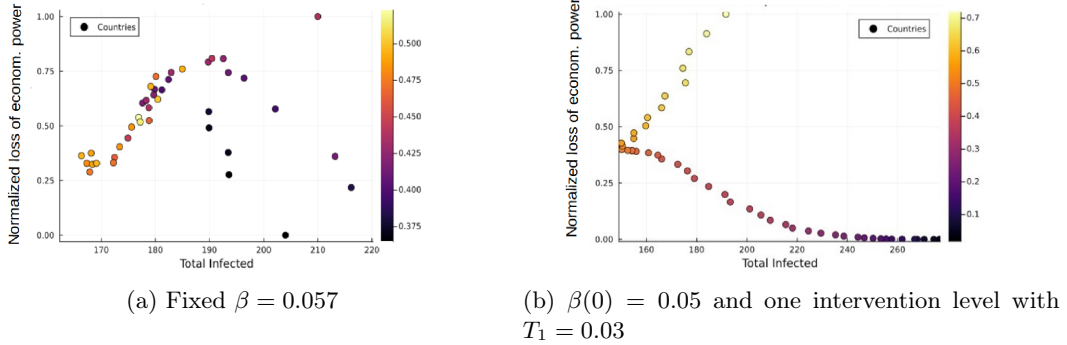

Figure 15: Scatter plots (with fixed β) of normalized loss of economic power C_e/C_t dependent on the total number $\int I(t)dt$ of infections. Each dot represents an individual country. The colour of the dots indicates the average of the stringency $1 - \eta$.

5 Limitations and Future Directions

Our work is a continuation of the approach in [6]. Accordingly, it uses a model with a similar structure. A SEIHRCDC compartment model representing epidemics is extended by a control unit, which stands for the government trying to mitigate epidemics by rising various countermeasures. The effects of these countermeasures on the epidemics are represented by modifications of the transmission rate β . In the paper, we have improved the approach in [6] by an additional step-wise cancellation of countermeasures, by the inclusion of psychological [10, 11] and economic aspects, and by adding vaccination as a possible countermeasure. The large number of parameters makes the analysis of the model behavior a demanding task. The paper focuses on validating and testing the model extensions rather than on providing detailed theoretical explanations of the system's behavior. Some standard procedures of epidemic model analysis, like stability or sensitivity analysis, were thus skipped. The lack of specific real-world data made an overall model calibration impracticable. In this respect, the psychological sub-model is the largest obstacle. Up to the knowledge of the authors, for example, data quantifying 'non-compliance' and similar measures seem to be missing. Accordingly, the validation of the model was essentially based on the replication of the qualitative behavior. In this context, the model conforms to general results quite well, as seen in the sections 4.1.5 and 4.2.1.

The paper aims at an improvement of the intervention management of epidemics. Here, the intervention strategy is represented by the thresholds T_i for raising specific intervention actions and the stringency $1 - \eta_i$ of the corresponding countermeasures. Taking psychological aspects and economic costs into account introduces additional objectives for the control unit beyond the straightforward reduction of the overall number of infections. First, minimizing non-compliance of the population to the proposed intervention regulations and second, minimizing economic impact. The results of the model analysis confirms the existence of trade-offs between these control objectives, but it was not possible to elaborate the details of the underlying connections between epidemiology, psychology, and economics. The back-effects between the evolution of epidemics and the psychological state of the population seem to be especially complex. Exploring the trade-off under different intervention strategies is subject to further research.

The psychological sub-model was able to reproduce some basic observations at a qualitative level. Some of the model assumptions of the authors in this respect may be challenged, however.

1. Compliance depends in the proposed model on the *actual* number of infections, but the spread of misinformation, the duration of epidemics, cultural differences, and the attitude of the government in unrelated areas may have a profound influence on the population's trust or mistrust in the government.
2. In the paper, a homogeneous population is assumed. This also holds for the ODE (2) for the evolution of non-compliance A . A personality-dependent model of compliance may help in further understanding.
3. The term $\max(0, (1 - \eta(s) - \Phi(s)))^3$ in the memory integral (2) assumes that under-performance by the government does not increase the population's mistrust. In the real world, this can clearly happen. On the other hand, mistrust may not necessarily lead to non-compliance.
4. It is necessary to narrow down the parameter values of the psychological sub-model to realistic ones. This applies in particular to the value of $A(0)$, which may be different for different parts of the population.

To summarise, a more detailed and better elaborated psychological sub-model could have the greatest potential for progress. This also concerns the learning process of the population. In fact, there is evidence that populations that are repeatedly affected by health hazards (such as epidemics) develop a greater tendency towards authoritarianism over time [32].

Despite of its simplicity, the economic sub-model is able to replicate basic real-world behaviour. However, as for the psychological sub-model, a more detailed economic model will be required to bring it closer to reality. Corresponding extensions may include, for example, taking into account the percentage of orders that can be performed remotely. This fraction is crucial for ensuring the continuity of economic production processes in case of a strict lockdown. Furthermore, a distinction can be made between 'essential' and 'non-essential' products.

Psychology and economics are two domains that can have a significant influence on the evolution and assessment of the outcome of an epidemic. To get a more complete picture about the situation, it may be useful to include other domains as well. One such example would be general 'mental health'. The proven increase in illnesses such as anxiety, depression and other mental health problems during the epidemic could have consequences [33] for both people's compliance and their economic productivity.

6 Discussion and Outlook

Countermeasures can mitigate the consequences of an epidemic outbreak significantly. In reality however, they may come with major drawbacks [34]. Apart from such unwanted side effects, countermeasures may also not necessarily achieve their intended goal of reducing the daily case numbers. People's compliance with the corresponding regulations influence the outcome of an epidemic sensitively.

The idea of non-compliance can, in principle, be transferred to other contexts beyond epidemics. Quite often, trust in someone's performance is relevant and susceptible to change. Modifications of the parameters M , $A(0)$ and b can adapt the psychological sub-model to new application domains. Particularly the parameter b , which determines the relative importance of recent events in relation to older ones, renders the equation adaptable. In our model, we adjust the incorporated compliance parameter based on the effectiveness of government actions and public perception. The representation of such mechanisms is not straightforward and even not done at all in e.g. [14] or [15]. Thus, alternative models may be considered as well.

References

- [1] Bill Gates. The next outbreak? we're not ready, 2015. TED Talk.
- [2] Bill Gates. *How to prevent the next pandemic*. Vintage, 2022.
- [3] Covid-19 statistics <https://www.worldometers.info/coronavirus/>.
- [4] Impact of the coronavirus pandemic on the global economy - statistics & facts <https://www.statista.com/topics/6139/covid-19-impact-on-the-global-economy/#editorspicks>.
- [5] Spanish flu statistics <https://ourworldindata.org/historical-pandemics>.
- [6] F. Zurek, L. Schwarzmeier, B. Dionisi Ferrera, C. Kuttler, and J. Draeger. Managing epidemics: Dynamic countermeasures and frictions. *MMSA Preprint*, 2024.
- [7] Joachim Draeger. Roadmap to a unified treatment of safety and security. In *Proceedings of the 10th Conference on System Safety and Cyber Security*. IET, 2015.
- [8] Joachim Draeger and Stefan Hahndel. Formalized risk assessment for safety and security. *preprint arXiv:1709.00567v2*, 2017.
- [9] Betty Pfefferbaum and Carol S North. Mental health and the covid-19 pandemic. *N. Engl. J. Med.*, 383(6):510–512, August 2020.
- [10] Tom Fischer, Tobias Gerwald, Sabine Lajos, Sabine Woellert, Christina Kuttler, and Joachim Draeger. Modeling the influence of the information domain on countermeasure effectiveness in case of COVID-19. In *Journal of Physics: Conference Series*, volume 2514, page 012009. IOP Publishing, 2023.
- [11] Tom Fischer, Tobias Gerwald, Sabine Lajos, Sabine Woellert, Christina Kuttler, and Joachim Draeger. A Model of the Mutual Influence between Epidemics and Rumors using Covid-19 as an Example. Technical report, Technical University of Munich and IABG mbH, To be published.
- [12] Joachim Draeger. Safety, security, and social engineering - thoughts, challenges and a concept of quantitative risk assessment. In Jeff M. Holder, editor, *A closer look at safety and security*, chapter 3. Nova Science Publishers, Inc., 2020.
- [13] Michael Siegrist and Alexandra Zingg. The role of public trust during pandemics. *Eur. Psychol.*, 19(1):23–32, January 2014.
- [14] Marc Oliver Rieger and Mei Wang. Trust in government actions during the COVID-19 crisis. *Soc. Indic. Res.*, 159(3):967–989, 2022.
- [15] Julie Hassing Nielsen and Johannes Lindvall. Trust in government in sweden and denmark during the COVID-19 epidemic. *West Eur. Polit.*, 44(5-6):1180–1204, September 2021.
- [16] Manuel Adrian Acuña-Zegarra, Mario Santana-Cibrian, and Jorge X Velasco-Hernandez. Modeling behavioral change and COVID-19 containment in mexico: A trade-off between lockdown and compliance. *Math. Biosci.*, 325(108370):108370, July 2020.
- [17] Edouard Mathieu, Hannah Ritchie, Lucas Rodés-Guirao, Cameron Appel, Charlie Giattino, Joe Hasell, Bobbie Macdonald, Saloni Dattani, Diana Beltekian, Esteban Ortiz-Ospina, and Max Roser. Coronavirus pandemic (covid-19). *Our World in Data*, 2020. <https://ourworldindata.org/coronavirus>.
- [18] Kaoru Hosono. Epidemic and economic consequences of voluntary and request-based lockdowns in japan. *J. Jpn. Int. Econ.*, 61(101147):101147, September 2021.
- [19] Rahmiye Figen Ceylan and Burhan Ozkan. The economic effects of epidemics: from SARS and MERS to COVID-19. *Research Journal in Advanced Humanities*, 1(2):21–29, June 2020.
- [20] Alexander Arnon, John Ricco, and Kent Smetters. Epidemiological and economic effects of lockdown. *Brookings Pap. Econ. Act.*, 2020(3):61–108, 2020.
- [21] Oliver Holtemöller. Integrated assessment of epidemic and economic dynamics. *IWH Discussion Papers*, (4), 2020.
- [22] Torben Dall Schmidt and Timo Mitze. Epidemic–economic complexity of COVID-19 policies across skill groups and geographies. *Reg. Stud.*, 58(2):322–335, February 2024.

- [23] Petrônio C L Silva, Paulo V C Batista, Hélder S Lima, Marcos A Alves, Frederico G Guimarães, and Rodrigo C P Silva. COVID-ABS: An agent-based model of COVID-19 epidemic to simulate health and economic effects of social distancing interventions. *Chaos Solitons Fractals*, 139(110088):110088, October 2020.
- [24] Rahmiye Figen Ceylan, Burhan Ozkan, and Esra Mulazimogullari. Historical evidence for economic effects of COVID-19. *Eur. J. Health Econ.*, 21(6):817–823, August 2020.
- [25] Clive Bell and Maureen Lewis. The economic implications of epidemics old and new. *SSRN Electron. J.*, 2005.
- [26] Elizabeth Brainerd and Mark V Siegler. DP3791 the economic effects of the 1918 influenza epidemic. <https://cepr.org/publications/dp3791>. Accessed: 2024-6-24.
- [27] Yunfeng Shang, Haiwei Li, and Ren Zhang. Effects of pandemic outbreak on economies: Evidence from business history context. *Front. Public Health*, 9:632043, March 2021.
- [28] Maia Martcheva. *An Introduction to Mathematical Epidemiology*, volume 61. Springer US, Boston, MA, 2015.
- [29] Pol Antras, Stephen J. Redding, and Esteban A. Rossi-Hansberg. Globalization and pandemics. *NBER Working Paper No. w27840*, 2020.
- [30] Elke Berger, Juliane Winkelmann, Helene Eckhardt, Ulrike Nimptsch, Dimitra Panteli, Christoph Reichebner, Tanja Rombey, and Reinhard Busse. A country-level analysis comparing hospital capacity and utilisation during the first covid-19 wave across europe. *Health Policy*, 126(5):373–381, 2022.
- [31] Seth Flaxman, Swapnil Mishra, Axel Gandy, H Juliette T Unwin, Thomas A Mellan, Helen Coupland, Charles Whittaker, Harrison Zhu, Tresnia Berah, Jeffrey W Eaton, Mélodie Monod, Imperial College COVID-19 Response Team, Azra C Ghani, Christl A Donnelly, Steven Riley, Michaela A C Vollmer, Neil M Ferguson, Lucy C Okell, and Samir Bhatt. Estimating the effects of non-pharmaceutical interventions on COVID-19 in europe. *Nature*, 584(7820):257–261, August 2020.
- [32] Damian R Murray, Mark Schaller, and Peter Suedfeld. Pathogens and politics: further evidence that parasite prevalence predicts authoritarianism. *PLoS One*, 8(5):e62275, May 2013.
- [33] Michael Daly and Eric Robinson. Depression and anxiety during COVID-19. *Lancet*, 399(10324):518, February 2022.
- [34] Helen Onyeaka and Christian Anumudu. Covid-19 pandemic: A review of the global lockdown and its far-reaching effects. *SageJournals*, 2021.